

# Berlin Kiosk

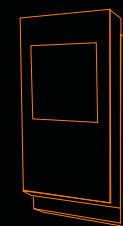

mail: [info@pointkiosk.si](mailto:info@pointkiosk.si) . tel.: +386 (0)5 3305 771 . fax.: +386 (0)5 3305 495



# Berlin

## The Thin-Walled Kiosk

### Technical Specifications Berlin Kiosk

Dimensions: H800 x W450 x D150  
Weight: aprox. 30 Kg.

The Berlin Model was developed specifically for indoor use, particularly for placing in walls.

This model is manufactured in stainless steel AISI304 or painted steel (RAL Colors) using steel plate of 1,5mm to 2,5mm which ensures the stability and rigidity of all structure.

The area where the computer is installed and possible peripherals (card readers, coin acceptors, etc.), is protected with access through a security lock and includes three power plugs.

On side of display are two integrated speakers that fits smoothly in the all structure.

The Berlin Model is normally equipped with a 17" XGA touch display (19", 22" or other sizes are possible).

The Berlin Model is normally equipped with a Atom CPU with a 160 GB hard drive, 1 Gb Ram Memory, a 128Mb graphic card and a 10/100 mb ethernet and Windows 7 Starter.



The Thin-Walled Kiosk  
**Berlin**

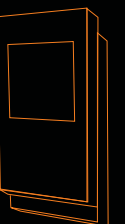

# Berlin

Distance comparison and main features

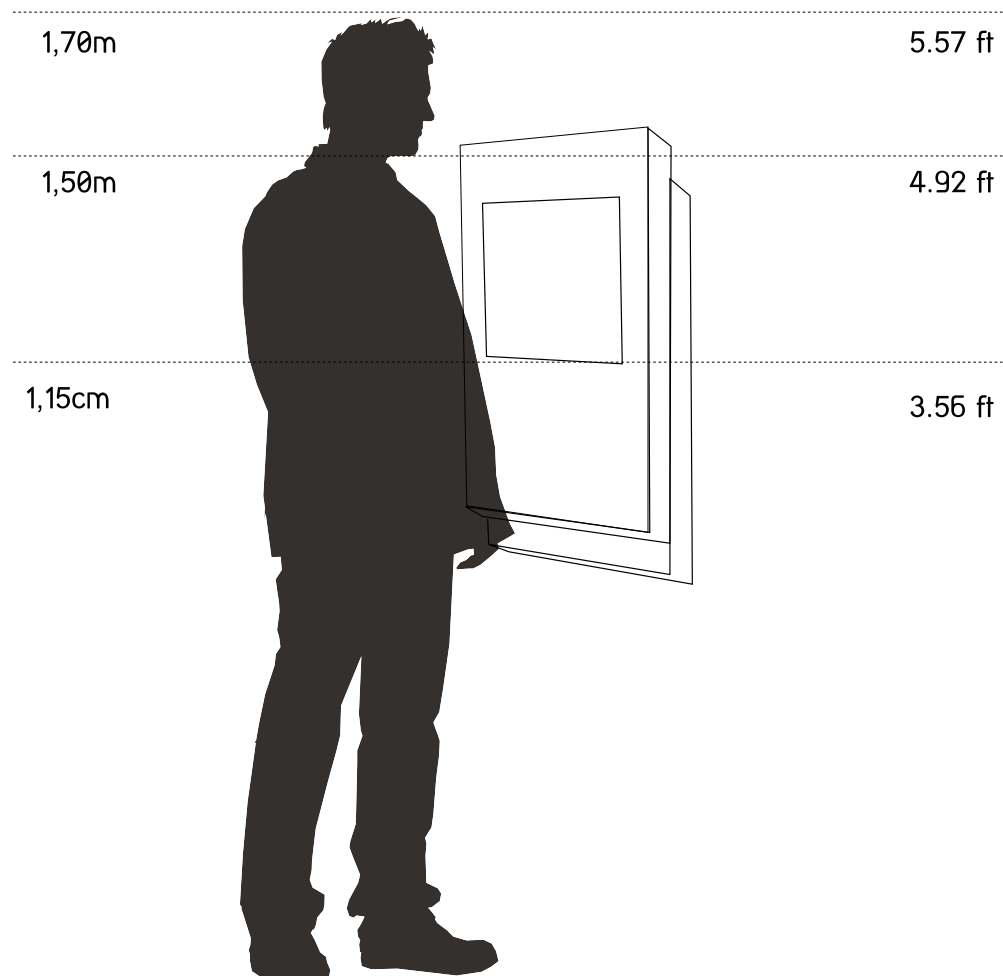

## Type

Wall

## Materials

Painted Steel

Stainless Steel

MDF

## Options

Webcam

Ticket Printer

Card Reader

Handset Phone

Ykiosk Software

Distance comparison and main features

# Berlin

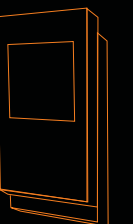

# Berlin

Kiosk measures

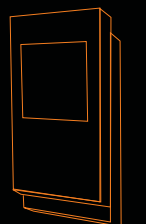
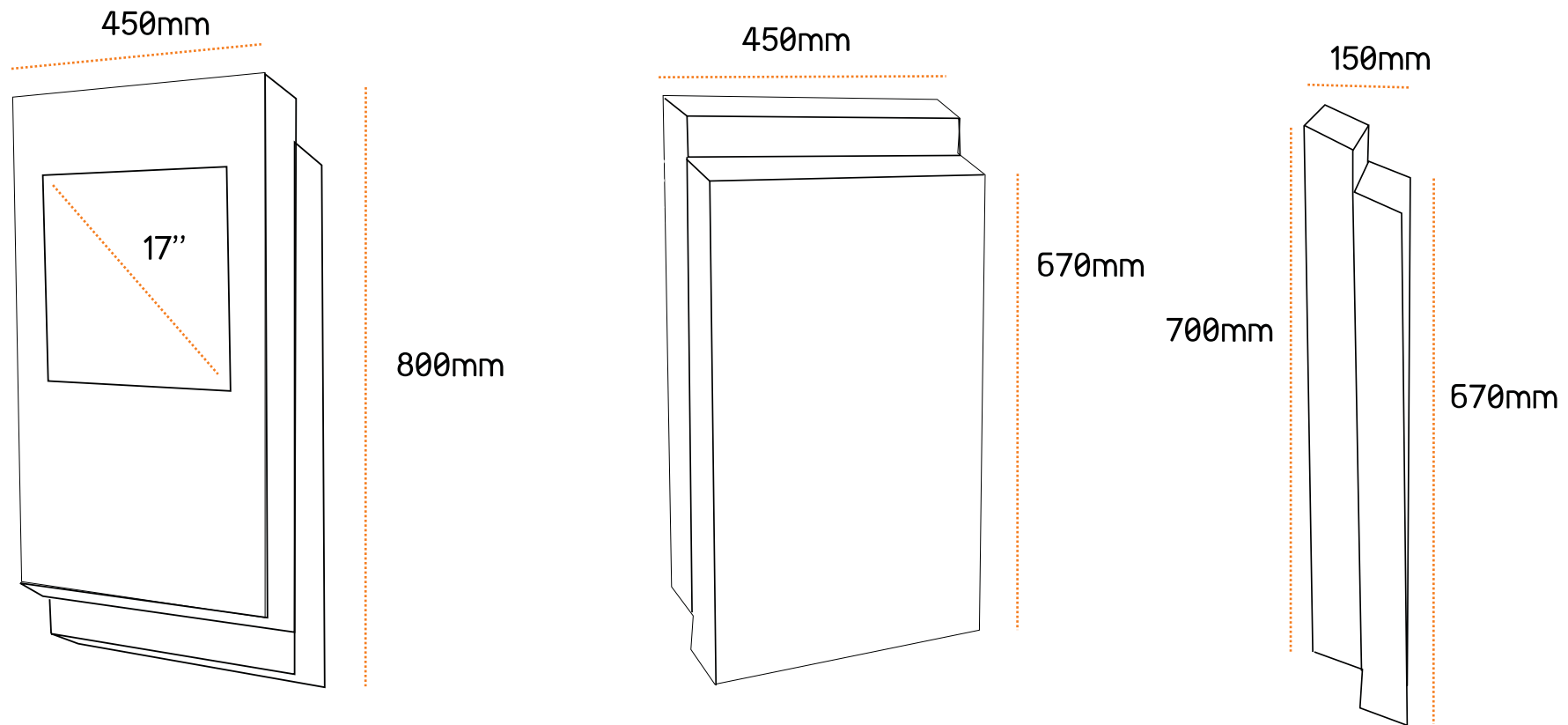

# Berlin

Technical data

---

## Dimensions:

- 17 inch (resolution: 1280 x 1024 Pixel)
- H780 W450 D15 , 30 kg

## Configuration:

- The Thin-Walled Kiosk
- Stainless steel AISI304 or painted steel (RAL Colors)
- Steel plate of 1,5mm to 2,5mm
- 17" XGA touchscreen display (resistive)
- Integrated speakers

## Optional:

- 19" to 24" Displays
- Atom or Dual Core PC computer
- Microsoft Windows 7 Professional
- Ykiosk software package
- Touch screen (SAW - antivandalism)
- Wireless networking - WLAN
- Bluetooth functionality
- Webcam

• Other components can be integrated changing kiosk dimensions: ticket printer, coin validator, bill validator, card readers, antivandalic keyboard, proximity sensor, etc.

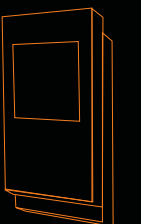



info@pointkiosk.si . tel.: +386 (0)5 3305 771 . fax.: +386 (0)5 3305 495

COBIT d.o.o., Industrijska cesta 5, Kromberk - p.p.235 -5001 Nova Gorica