

Impact Kiosk

PATENTED - DESIGN MODEL N°. 2033

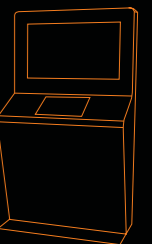

mail: info@pointkiosk.si . tel.: +386 (0)5 3305 771 . fax.: +386 (0)5 3305 495



Impact

Interactivity with dimension

The Impact model was designed specially for outdoor applications.

This model can be manufactured in stainless steel or painted steel (available in all RAL colors) using steel plate of 1,5mm to 2,5mm which ensures the stability and rigidity of the all structure.

This Kiosk is designed specially for information and/or multimedia advertising purposes.

The two parts of the kiosk are designed so that there is a great versatility. In the standard version of this kiosk, the lower monitor is touchscreen for better interactivity with the user.

The area where computer is installed and possible peripherals (card readers, coin acceptors, etc.), is protected with access through a security lock and includes a base with three power plugs.

One of the main characteristics of these kiosks is its design that allows integrating a large number of peripheral devices (card readers, tickets printer, coin acceptors, etc.) without having to redesign large pieces which gives this model great versatility and increases the applications field.

The Impact Model can be equipped with a Atom CPU with a 160 GB hard drive, 1 Gb Ram Memory, a 128Mb graphic card and a 10/100 mb ethernet, and Windows 7 Starter.

This kiosk can be produced with glass protection (top and 2 laterals) for outdoor environments.

Technical Specifications Impact Kiosk

Dimensions: H2000 x W1200 x D600
Weight: aprox. 120 Kg.



PATENTED - DESIGN MODEL N°. 2033

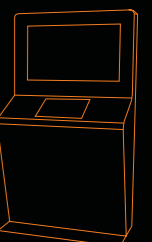

Impact

Distance comparison and main features

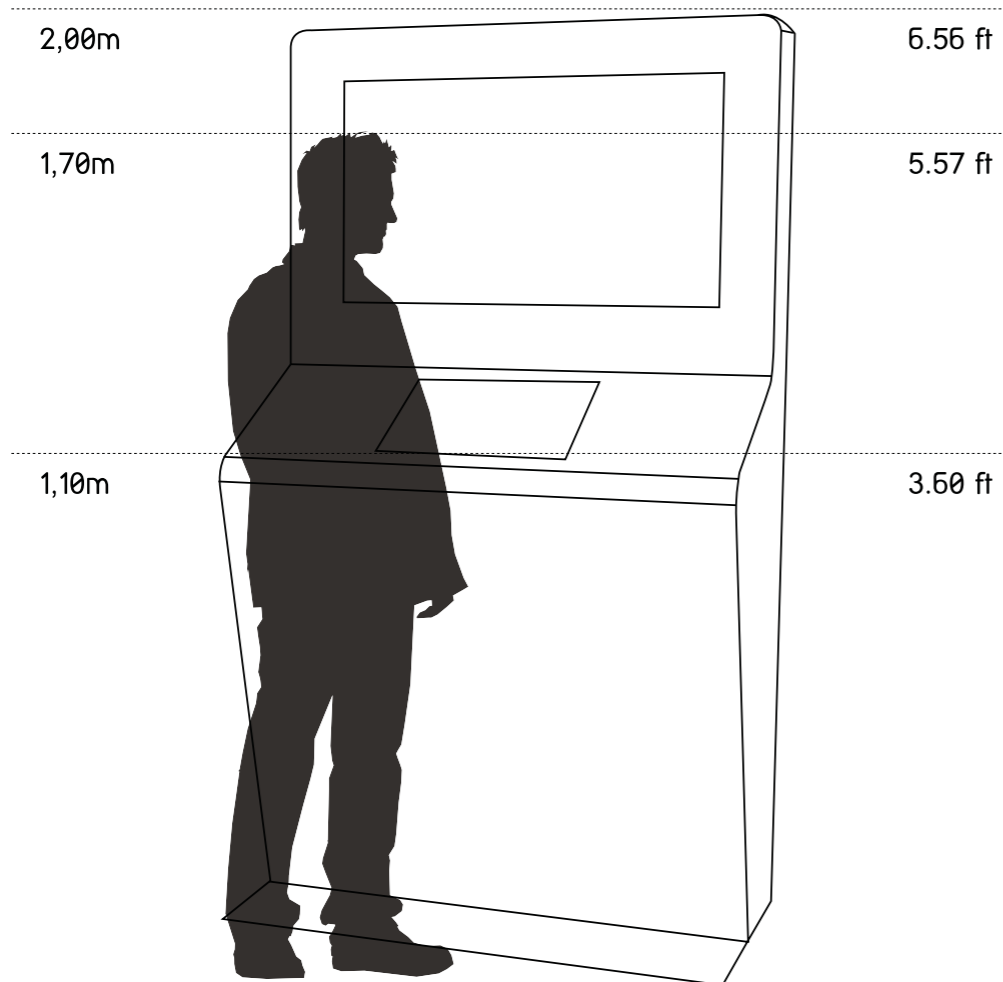

Type

- Indoor / Outdoor

Materials

- Painted Steel
- Stainless Steel

Options

- Large Displays 17" to 103"
- YdSignage Software
- Double Face Displays (Touchscreen or TFT)
- Glass Protection

Distance comparison and main features

Impact

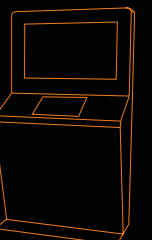

Impact

Kiosk measures

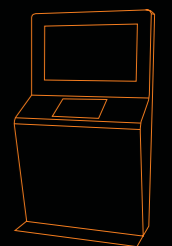
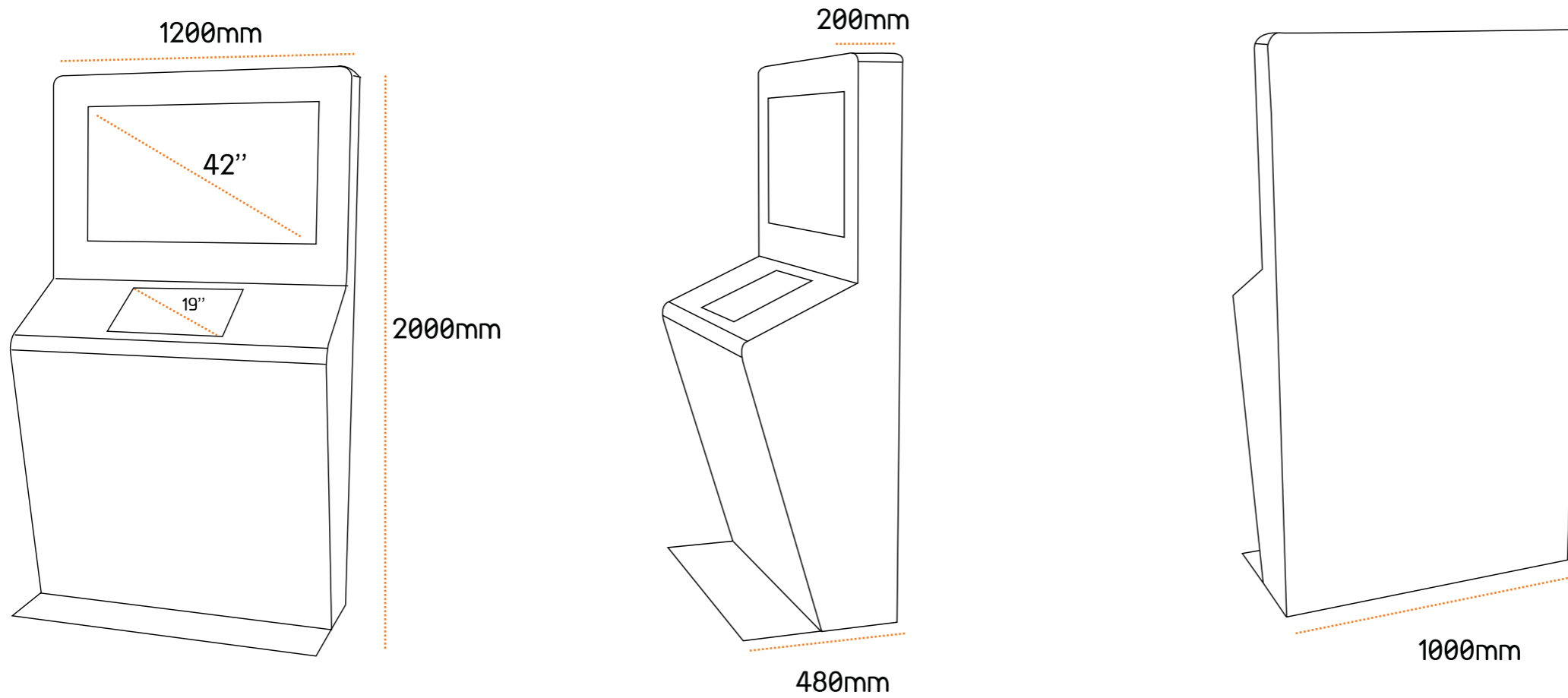

Impact

Technical data

Dimensions:

- Top display 42" (resolution: 1920x 1080 Pixels)
- Low display 19" (resolution: 1024x 768 Pixels)
- H2800 W650 D200 mm

Weight:

140 kg

Configuration:

- Advertising and Interactive
- Stainless steel AISI304 or painted steel (RAL Colors)
- Steel plate of 1,5mm to 2,5mm
- Top display 42"
- Low display 19"
- Integrated speakers

Optional:

- 19" to 45" Displays
- Atom or Dual Core PC computer
- Microsoft Windows 7 Professional
- Ykiosk software package
- Touchscreen (Infrared, optical, capacitive)
- Wireless networking - WLAN
- Bluetooth functionality
- Webcam

• Other components can be integrated changing kiosk dimensions: ticket printer, coin validator, bill validator, card readers, antivandalic keyboard, proximity sensor, etc.

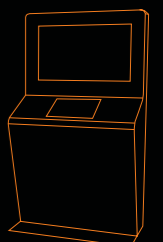



info@pointkiosk.si . tel.: +386 (0)5 3305 771 . fax.: +386 (0)5 3305 495

COBIT d.o.o., Industrijska cesta 5, Kromberk - p.p.235 -5001 Nova Gorica